

INSTALLATION, OPERATION & MAINTENANCE GUIDE

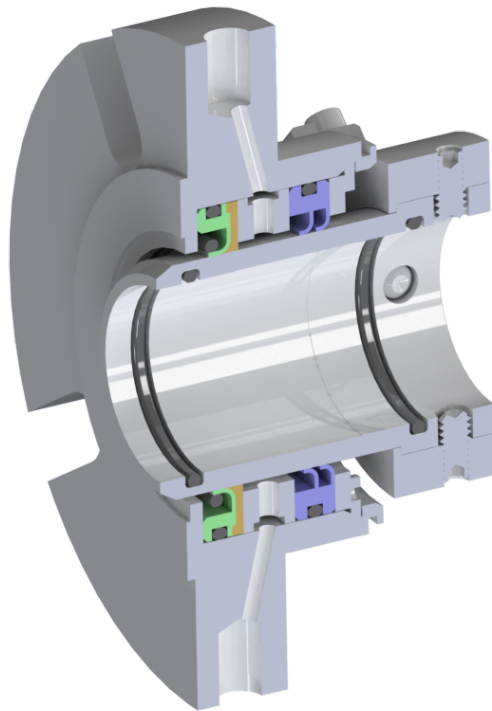

STYLE MLC3



Headquarters

291 Hurricane Lane
Williston, VT 05495

TEL: (802) 878-8307
FAX: (802) 878-2479

Brazil

Rua Javaés, 441/443
Bom Retiro, Sao Paulo
Brazil CEP 01130-010

TEL: 55-11-3736-7373
FAX: 55-11-3736-7355

Gulf Coast

1719 South Sonny Avenue
Gonzales, LA 70737

TEL: (225) 484-0007
FAX: (225) 341-8922

Texas

Houston
7545 E. Orem Drive
Houston, TX 77075
TEL: (832) 804-7424

Odessa
801 S. Pagewood Avenue
Suite 2, Odessa, TX 79761
TEL: (432) 300-0167

REVISED: September 2022



OVERVIEW

This guide outlines the installation, operation and maintenance of a Flexaseal Style MLC3 Multiple Lip Cartridge seal. This guide, in addition to the manuals provided by the pump manufacturer and the manufacturer of any auxiliary equipment, should be read in its entirety prior to installation.

NOTICE

Flexaseal does not assume responsibility for misuse, or any damages incurred as a result of the misuse of the supplied sealing system. Contact a Flexaseal representative before making any changes to the provided system or design.

SAFETY

1. Read all instructions thoroughly prior to beginning installation. Review engineering prints for special notes and/or instructions.
2. Removal, installation, operation, and maintenance must only be carried out by qualified personnel who have thoroughly read all instructions.
3. The seal must only be used for its intended application. Flexaseal cannot be held liable for use outside the scope of the recommended application.
4. Inspect the replacement seal prior to removal of the old seal or installation of the new seal using the technical information provided in this document. Contact a Flexaseal representative if there are any questions.
5. Follow plant safety regulations and procedures throughout the disassembly/installation process including, but not limited to, the following:
 - Lockout/tagout procedures
 - SDS consultation for any hazardous materials involved
 - Use of proper personal protective equipment
 - Relief of any system pressure and mechanical energy
6. The following symbols have been used throughout the document to highlight important information:
 -  Instructions intended to prevent damage to the seal or equipment.
 -  Mandatory instructions intended to prevent personal injury or extensive damage to equipment.
 - NOTE:** Information to note while installing, or for later use.

Style MLC3 Maximum Operating Conditions

Viscosity	500,000 cP
Pressure	300 psi (20 bar)
Temperatures (w/ environmental control)	-100 to 400°F (-73.3 to -267.7°C)
Surface speeds (dry running)	3000 fpm (15.24 m/s)
Surface speeds (w/ environmental control)	5000 fpm (25.4 m/s)

NOTE: Maximum temperature, pressure, and speed indicate operating extremes independently and do not imply the seal will function at these extremes at the same time. Contact Flexaseal if in doubt.

PREPARATION



Verify that equipment has been properly shut off and rendered inoperative according to plant safety protocol (e.g. lockout/tagout procedures).

1. Disassemble the pump seal chamber, in accordance with the pump OEM instructions, to expose the existing seal.

NOTE: Document how the seal chamber is disassembled for re-assembly.

2. Carefully remove the existing sealing device, taking care not to damage the shaft.
3. Clean the shaft, shaft sleeve (if present), and seal chamber face of rust, burrs, grit, sharp

edges, and set screw damage using fine emery cloth. Wipe clean.

ATTENTION

Avoid making flat spots or reducing the shaft diameter.

4. If the pump is equipped with a shaft sleeve, verify the condition of its O-ring or gasket and ensure that it is properly located (fully engaged against step/hook/snap ring).
5. Sealing surfaces and the shaft or shaft sleeve must have at least a 63 Ra-µin surface finish as seen in [Figure 1](#).
6. For ease of installation, the leading edge of the shaft or sleeve should be chamfered as shown in [Figure 1](#) and all parts should be deburred.

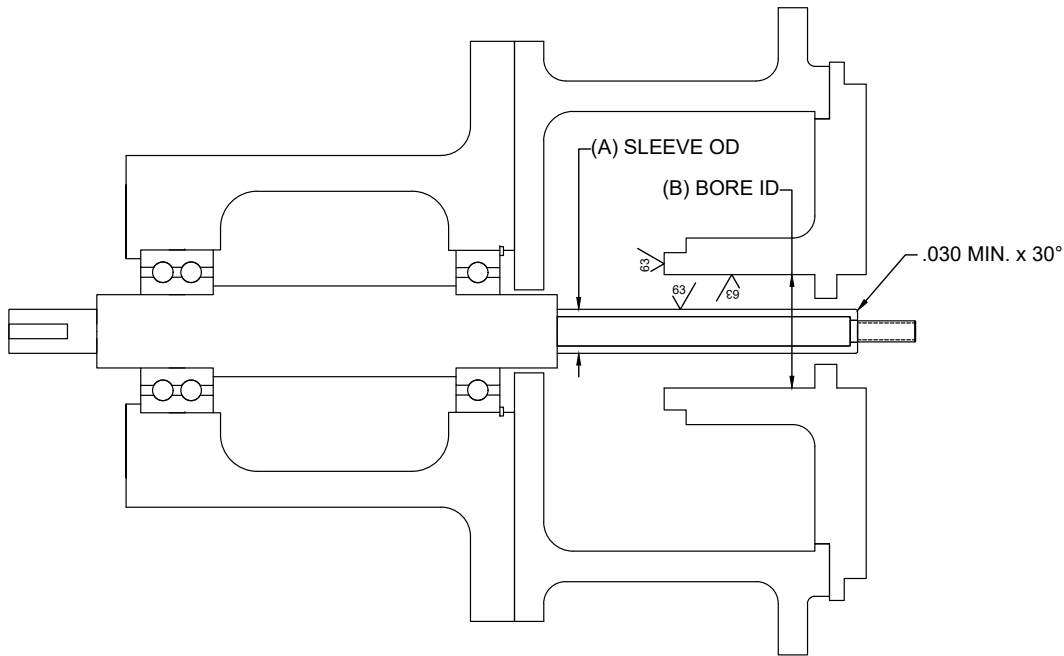

Figure 1: Surface finish and chamfer locations. Fully assembled pump without seal.

VERIFICATION

Successful operation of a Style MLC3 seal is contingent on conforming equipment dimensions and alignment. Verify the following prior to continuing:

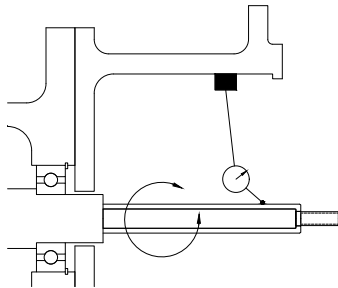

Figure 2: Shaft Runout

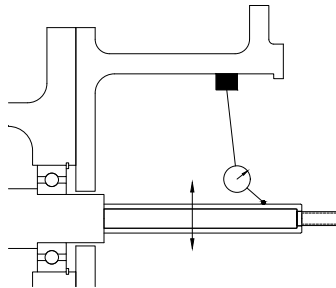

Figure 3: Bearing Fit

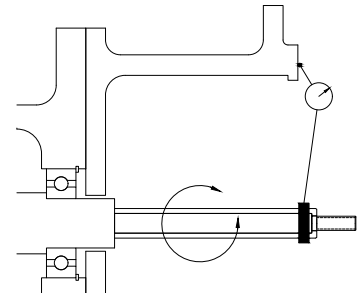

Figure 4: Bearing Frame Perpendicularity

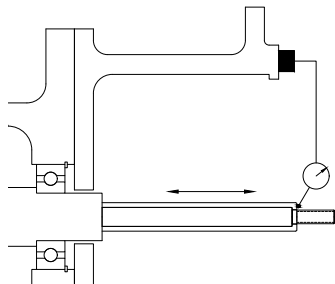

Figure 5: Axial Shaft Movement

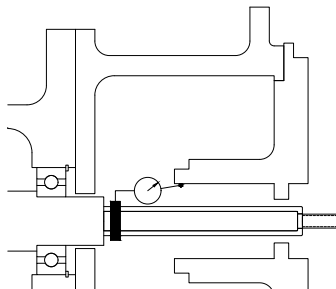

Figure 6: Seal Chamber Bore Concentricity

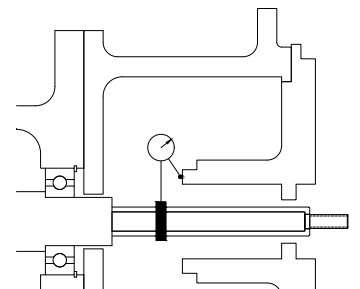

Figure 7: Seal Chamber Face Squareness

Maximum Alignment Variation (TIR)

Fig. 2	Radial shaft movement (shaft runout)	0.020 in. normal/0.025 in. low speed
Fig. 3	Radial bearing fit	0.002–0.003 in.
Fig. 4	Bearing frame perpendicularity	0.0005 in./in.
Fig. 5	Axial shaft movement (end play)	0.125 in.
Fig. 6	Seal chamber bore concentricity	0.005 in.
Fig. 7	Seal chamber face squareness	0.0005 in./in.

For proper function and satisfactory operation of the seal it is imperative that connections, dimensions, finishes, and alignments are all acceptable based on the specified design. If measured values exceed the values given above, adjust the equipment to meet the specifications before installing the seal. These values are general guidelines and the pump OEM should be used to verify acceptable values whenever possible.

SEAL INSTALLATION

Ensure alignment verification of equipment has been completed prior to starting the installation procedure. Review engineering prints for special notes and/or instructions.

NOTE: It is essential to use a suitable lubricant when installing a seal, as different lubricants will work better with different elastomers.

1. Disassemble the pump until the seal chamber and shaft are accessible.
2. Remove the seal from its packaging and inspect for damage to any components.

NOTE: Cartridge seals are shipped from Flexaseal fully assembled and should not be disassembled without cause. If a seal appears damaged prior to installation, contact a Flexaseal representative.

3. Ensure the shaft and seal housing have been properly cleaned as described in the preparation section.
4. Lightly lubricate the seal sleeve O-ring with a suitable and compatible lubricant.

5. Gently slide the seal on the shaft with the gland gasket facing, but clear of the seal chamber.
6. Reassemble the pump as described by the pump OEM.
7. If the gland is equipped with a gland gasket, lubricate the gland bolts and bolt the gland to the seal chamber using the Legacy Method (Star Pattern) according to torque values specified in the table below. Be sure not to overtighten the gland bolts as this may distort the gland and internal components resulting in seal leakage.

NOTE: For seals with a register fit or a metal-to-metal mate with the seal chamber, standard torque-tension specification for bolts and studs is sufficient.

8. Alternately tighten the provided set screws to the specified torque value according to the table below.
9. Remove the setting clips from the seal. Save these for future use in seal removal or impeller adjustment.

Torque Rating for Cartridge Seal Gland Bolts (Flat Gasketed Gland)

Shaft Size	1.000–2.000 in. 24–50 mm	2.125–3.250 in. 53–80 mm	3.375–4.000 in. 85–100 mm
Recommended Torque	20 ft.-lbs. 27 N-m	25 ft.-lbs. 34 N-m	30 ft.-lbs. 41 N-m

Cup Point Set Screw Torque Specifications

Screw Size	Alloy Steel	Stainless	Screw Size	Alloy Steel	Stainless
#10	36 in.-lbs.	26 in.-lbs.	M4	2.0 N-m	1.5 N-m
1/4	87 in.-lbs.	70 in.-lbs.	M6	7.9 N-m	6.1 N-m
5/16	165 in.-lbs.	130 in.-lbs.	M8	19.6 N-m	15.4 N-m
3/8	290 in.-lbs.	230 in.-lbs.	M10	37.0 N-m	29.5 N-m
1/2	620 in.-lbs.	500 in.-lbs.	M12	60.3 N-m	48.3 N-m

BEFORE STARTING THE EQUIPMENT

1. Ensure the pump shaft is properly aligned at the coupling with the motor.
2. Check that all gland plate bolts and all screws are securely fastened.
3. Once the pump is reassembled, turn the shaft by hand if possible to check for free rotation, if not, recheck installation.
4. Verify that all plumbing and piping plans for the seal are connected and configured according to best practice.
5. Flood the pump, vent all air from the seal chamber, and check the seal for leakage.
6. Ensure all plumbing and venting are free of obstruction and that the chamber is filled with liquid. Check that all alarms connected to auxiliary systems are properly functioning to alert personnel if any issues arise.
7. Start the pump per the pump manufacturer's recommendations, observe for proper operation, and check for excessive heat at the seal gland.

ATTENTION

Check periodically during operation to ensure that the seal is not overheating.

OPERATION & MAINTENANCE

If leakage is detected, it should be addressed as soon as possible to prevent hazards and protect personnel. Leakage could come from a number of leak paths in the seal, or be caused by changes in the pump operation or condition. Although seals should be inspected regularly for signs of leakage, a properly selected and functioning seal will run for extended durations without need for extra attention and should not be disturbed unnecessarily (i.e. shut down and disassembled without cause). Below is an inexhaustive list of possible causes of leakage.

Primary Causes

- Damaged seal lips
- Damaged O-rings
- Damaged springs
- Damaged seal sleeve

Secondary Causes

- Change in duty conditions
- Worn bearings
- Increased vibration

It is important to periodically inspect and maintain flush systems, shaft alignment, and consistent duty parameters to ensure the seal performs as designed. Often, there is a case of cause & effect with machinery and processing issues upstream that can cause a seal to leak. Check for the root cause of leakage when disassembling equipment for inspection or service.

DECOMMISSIONING EQUIPMENT

When decommissioning equipment it is important to ensure that the pump has been fully isolated from the process and power sources for personnel safety. Pressure and fluid should be fully released before disassembly of the equipment is to begin.



If the equipment has been used with toxic or hazardous fluids, ensure that it is decontaminated and neutralized before decommission begins. There is often residual fluid remaining from the draining process so consult the pump OEM for special cases.

REMOVING THE SEAL



Before opening the pump to remove the seal the warning stated above regarding toxins and hazardous products must be reiterated. Make note of all fluids contained in the pump, drain and decontaminate before opening the housing for seal service.

1. Ensure all fluid has been drained and vented. Equipment should be shut down and locked/tagged out according to OEM and plant specifications.
2. Dismantle the equipment sufficiently so that the gland plate and seal housing are exposed and accessible for service.
3. Reset the setting clips that were saved from installation.
4. Back-out the cup point set screws.
5. Remove the gland bolts/nuts in an even manner.
6. Carefully slide the seal out and off of the shaft.



If a part is going to be returned for service or to any third party, all shipments should have appropriate safe-handling instructions securely attached to the package.

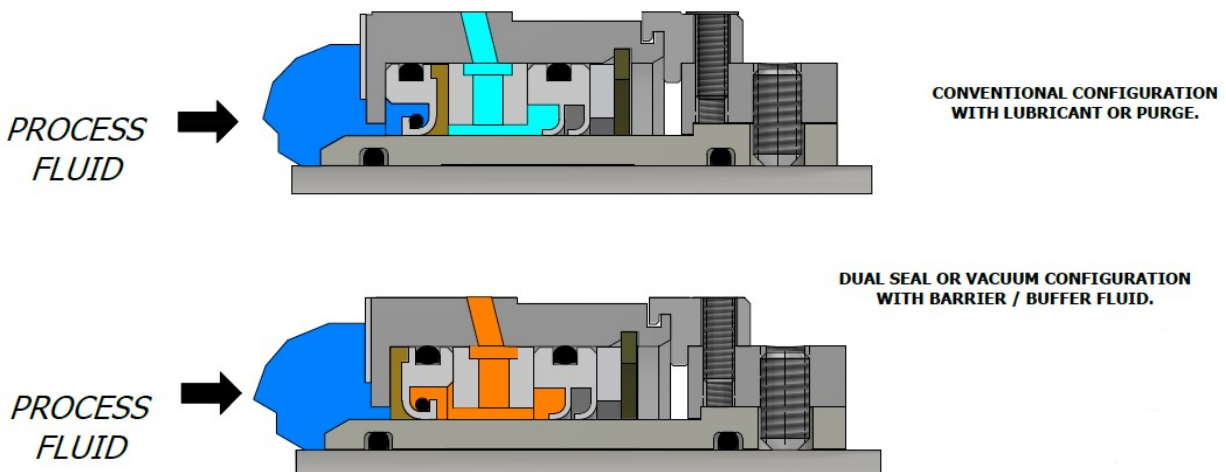

LIMITED WARRANTY AND LIMITATION OF LIABILITY:

SEAL PRODUCTS



Flexaseal Engineered Seals and Systems, LLC (hereinafter referred to as "FAS") warrants that new goods manufactured by FAS (with the exception of "wear parts" or consumables all of which are not warranted) will be free from defects in material and workmanship (the "Warranty"). The Warranty shall be in effect for a period of the earlier of three (3) months from the date of installation or six (6) months from the date of shipment from FAS's facility (which date of shipment shall not be greater than thirty (30) days after receipt of notice that the goods are ready to ship) (the "Warranty Period"). FAS shall, at its option and expense, either repair, replace, or refund amounts paid for any goods that fail to conform to the Warranty. In no case shall FAS be obligated to remove the defective goods or install the replaced or repaired goods, and the end user shall be responsible for providing ready access to the goods and areas for warranty work, and all other associated costs, including, but not limited to, service costs, shipping fees, and expenses. FAS shall have complete discretion as to the method or means of repair or replacement. The end user's failure to comply with FAS's repair or replacement directions shall constitute a waiver of its rights and render all warranties void. Any goods repaired or replaced under the Warranty are warranted only for the balance of the Warranty Period on the goods that were repaired or replaced. The Warranty is conditioned on the end user giving written notice to FAS of any goods that fail to meet the Warranty within ten (10) days of the date when any defects first become apparent. FAS shall have no warranty obligations to the end user with respect to any goods or parts of a good that: (a) have been repaired by parties other than FAS or without FAS's written approval; (b) have been subject to misuse, misapplication, neglect, alteration, accident, or physical damage; (c) have been used in a manner contrary to FAS's instructions for installation, operation and maintenance; (d) have been damaged from ordinary wear and tear, corrosion, or chemical attack; (e) have been damaged due to abnormal conditions, vibration, failure to properly prime, or operation without flow; (f) have been damaged due to a defective power supply or improper electrical protection; or (g) have been damaged resulting from the use of accessory Products not sold by FAS or not approved by FAS in connection with goods supplied by FAS.

THE FOREGOING WARRANTY IS EXCLUSIVE AND IN LIEU OF ANY AND ALL OTHER EXPRESS, ORAL, OR IMPLIED WARRANTIES, GUARANTEES, CONDITIONS OR TERMS OF WHATEVER NATURE RELATING TO THE GOODS PROVIDED HERewith, INCLUDING WITHOUT LIMITATION, ANY IMPLIED WARRANTIES OF MERCHANTABILITY AND FITNESS FOR A PARTICULAR PURPOSE, WHICH ARE HEREBY EXPRESSLY DISCLAIMED AND EXCLUDED. END USER'S EXCLUSIVE REMEDY AND FAS'S AGGREGATE LIABILITY FOR BREACH OF ANY OF THE FOREGOING WARRANTIES ARE LIMITED TO THE REPAIR, REPLACEMENT, REPERFORMANCE, OR REFUND.

IN NO EVENT SHALL FAS'S LIABILITY ARISING OUT OF OR IN ANY WAY RELATED TO THE GOODS EXCEED THE AMOUNT PAID BY END USER UNDER THIS AGREEMENT. FAS SHALL HAVE NO LIABILITY FOR LOSS OF PROFIT, LOSS OF ANTICIPATED SAVINGS OR REVENUE, LOSS OF INCOME, LOSS OF BUSINESS, LOSS OF PRODUCTION, LOSS OF OPPORTUNITY, LOSS OF USE, LOSS OF REPUTATION, BUSINESS INTERRUPTION, DOWNTIME, INDIRECT, CONSEQUENTIAL, INCIDENTAL, PUNITIVE OR EXEMPLARY DAMAGES, HOWSOEVER ARISING, WHETHER IN WARRANTY, CONTRACT, TORT, PRODUCT LIABILITY, STRICT LIABILITY, OR OTHERWISE, REGARDLESS OF WHETHER FAS HAS BEEN APPRISED OF THE POSSIBILITY OF SUCH LOSSES IN ADVANCE.

This warranty and limitation of liability shall be governed and construed in accordance with the laws of the State of Delaware, USA. Sole and exclusive venue for any claim or controversy arising out of or in any way related to this warranty and limitation of liability shall be in a state court located in Chittenden County, Vermont, USA.

www.flexaseal.com

Vermont	Brazil	Louisiana	Texas
800.426.3594	55.11.3736.737	225.484.0007	832.804.7424

**FAS SW
V2.2020**